



Instruction Manual

AE OUTDOOR 1PC DINING TABLE

Item No. TQ11040



For product assistance &
missing or replacement parts:
WE CAN HELP

 Support@aeoutdoor.com

www.aeoutdoor.com

CONTENTS & INFORMATION

Contents & Information	2	Parts Diagram	4
Safety Precautions	2	Assembly	5-6
Pre-as Sembly	2	Care And Maintenance	7
Model Description	3		
Finished Assembled Product			
.....	3		
Hardware	3		

FEATURES

- Durable steel frame for a long life.
- Easily assembled with the included instructions

SAFETY PRECAUTIONS

ATTENTION

Use the correct bolts

- Use the correct bolts as indicated. Do not tighten any of the bolts until the product is completely assembled.

Do not discard packaging

- Do not discard any of the packaging until you have checked that you have all of the required parts.



Keep children away during assembly

- This item contains small parts that can be swallowed by children. Children should always be under direct adult supervision while using this product.
- Retain assembly instructions for future reference.

PRE-ASSEMBLY

- Carefully remove all pieces from the carton and make sure that you have all parts (refer to the hardware and parts content list).
If you are missing parts, Email: support@aeoutdoor.com for further assistance.
- To avoid scratching your set, please assemble on top of the packaging cardboard or on top of a rug.

MODEL DESCRIPTION

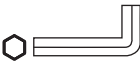
SETUP		TOOLS NEEDED
		 Allen key



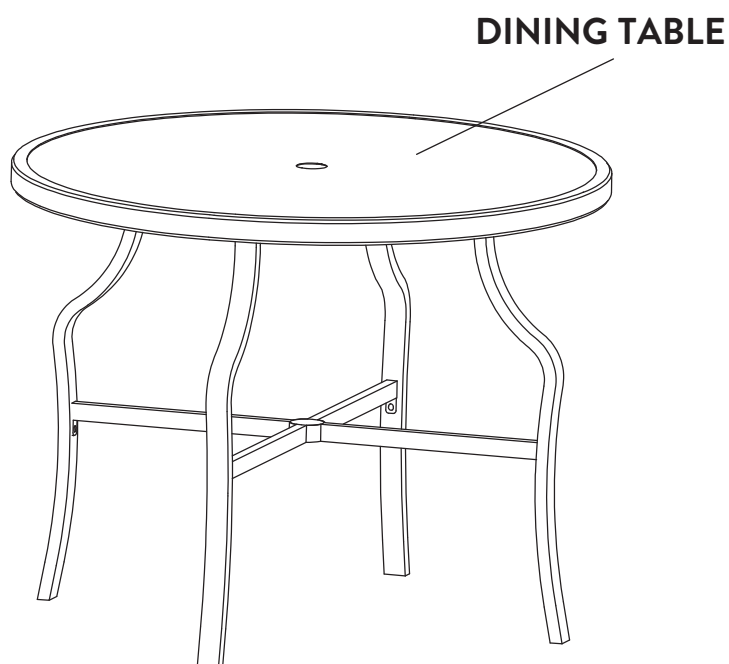

FINISHED ASSEMBLED PRODUCT

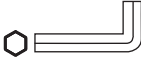

HARDWARE

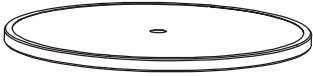
PART	DESCRIPTION	PICTURE	QTY
AA	BOLT(M6X15)		12
BB	ALLEN KEY		1

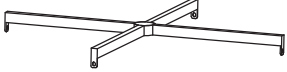
PARTS DIAGRAM

		
A X1 Table top	B X4 Table leg	C X1 Retaining frame
		
D X1 Umbrella hole cover		

ASSEMBLY

1. DINING TABLE

STEP 1

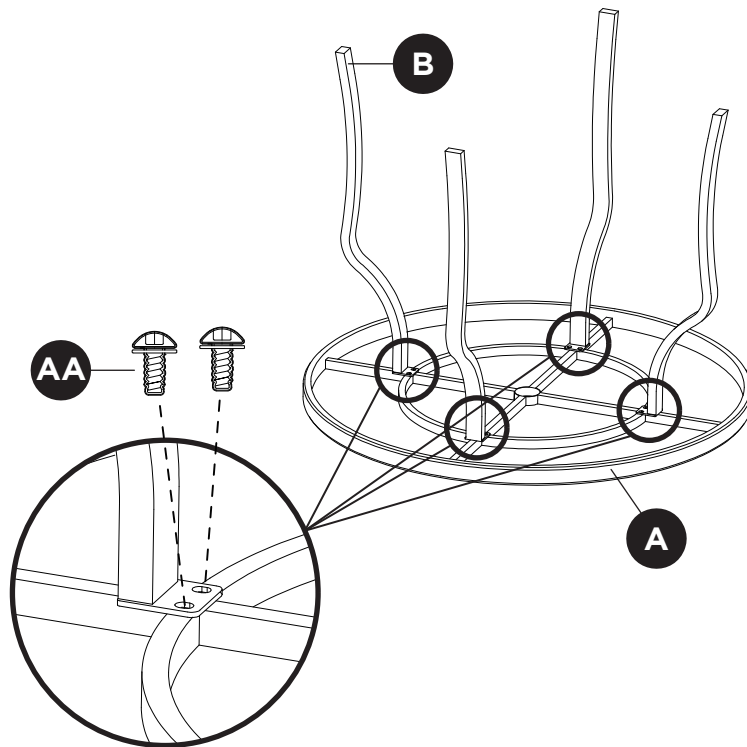

A x1

Table top



B x4

Table leg



AA x8

Bolt(M6X15)



STEP 2

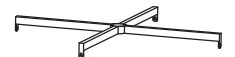
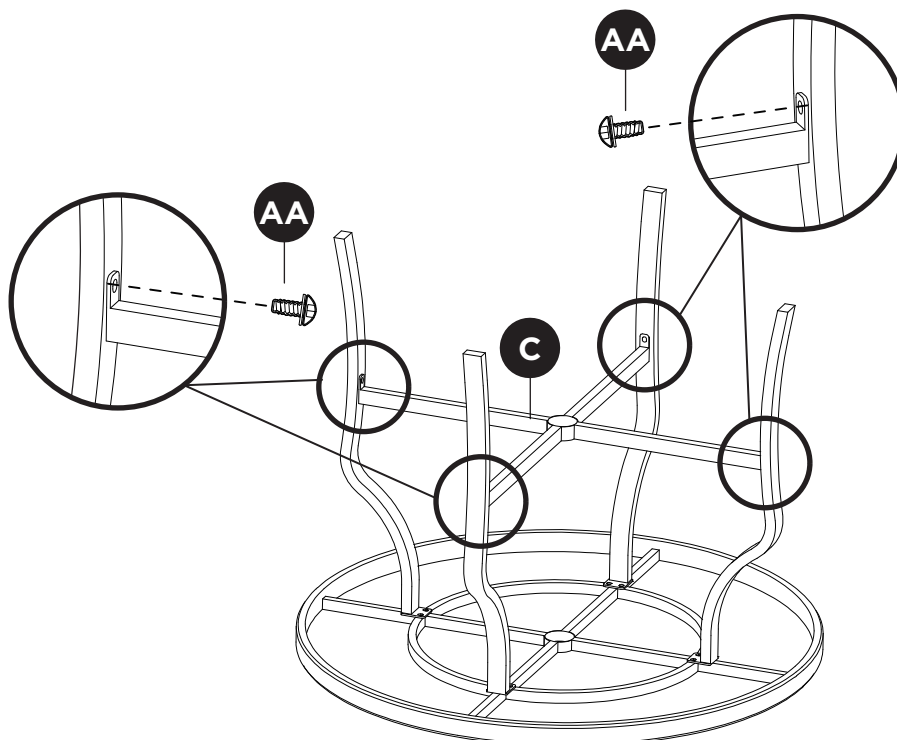

C x1

Retaining frame



AA x4

Bolt(M6X15)



ASSEMBLY

DINING TABLE

STEP 3

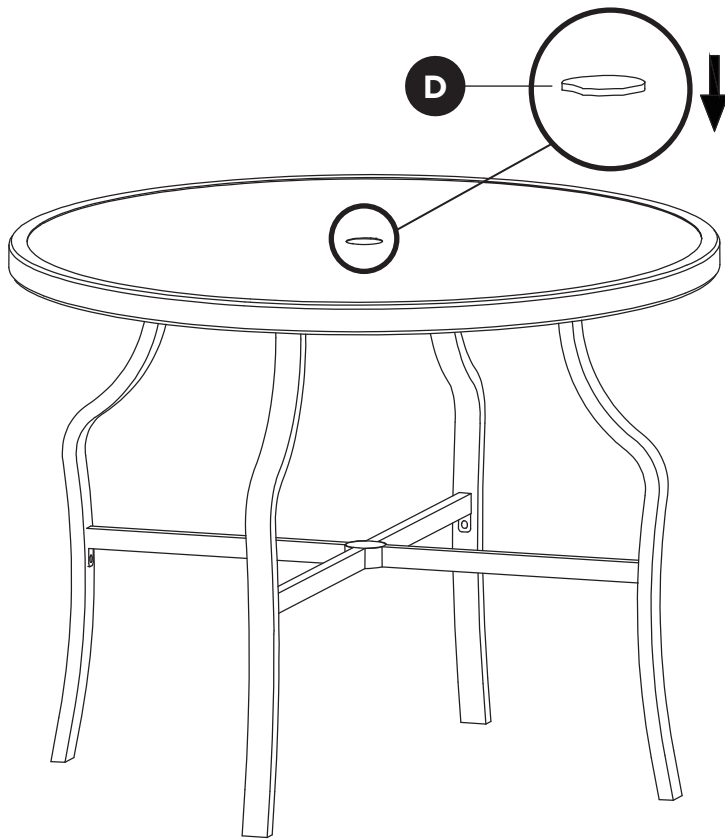

D x1

Umbrella hole cover

STEP 4



CARE AND MAINTENANCE

- Use a furniture cover when not in use.
- Inspect and tighten all bolts and fasteners on a regular basis to ensure the proper performance and safety of your product.
- In order to prolong the life and beauty of your furniture, we recommend that it be stored in a dry and protected area during off season periods.
- Be careful to never allow water to build up in the frames as this will cause corrosion and freeze damage in cold climates.
- Wash all frames with a solution of mild soap and water. Rinse with clean water and dry with a soft absorbent cloth towel.
- Frames can be treated with a liquid wax for maximum protection against UV rays and/or salty, damp air.
- Do not use bleach or solvents to clean any product!

Should you have any issues, please don't hesitate to contact us.

Email: Support@aeoutdoor.com