

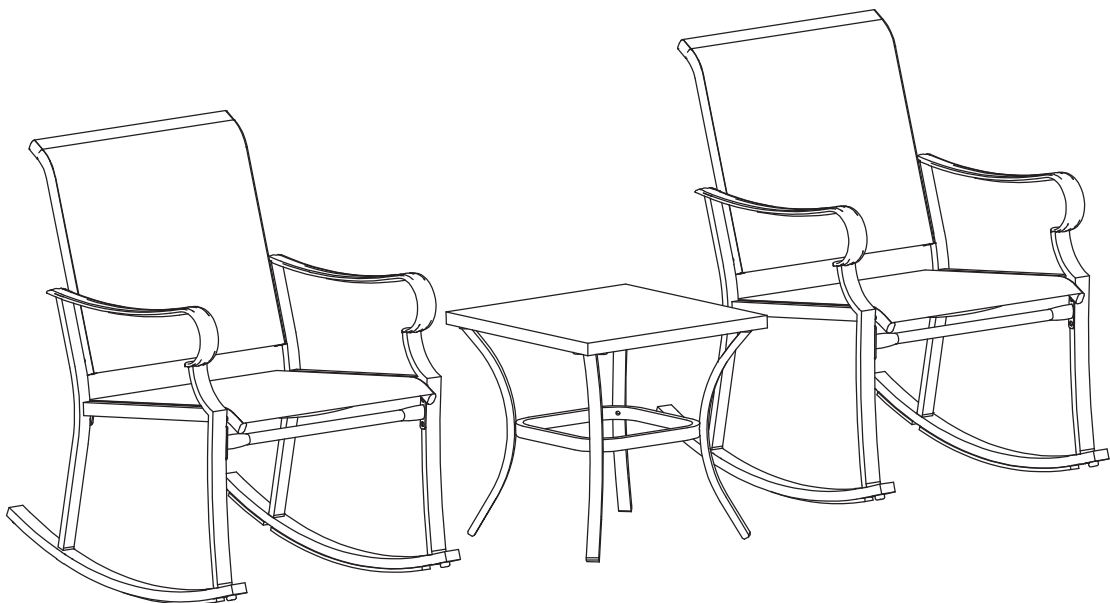

Instruction Manual

# AE OUTDOOR 3PC ROCKING CHAIR SET

Item No. S1101JA



For product assistance &  
missing or replacement parts:  
WE CAN HELP

 [Support@aeoutdoor.com](mailto:Support@aeoutdoor.com)

[www.aeoutdoor.com](http://www.aeoutdoor.com)

# CONTENTS & INFORMATION

|   |   |                            |     |
|---|---|----------------------------|-----|
| <b>Contents &amp; Information</b> ..... | 2 | <b>Parts Diagram</b> ..... | 4   |
| Safety Precautions .....                | 2 | <b>Assembly</b> .....      | 5-8 |
| Pre-as Sembly .....                     | 2 | Care And Maintenance ..... | 8   |
| <b>Model Description</b> .....          | 3 |                            |     |
| Finished Assembled Product              |   |                            |     |
| .....                                   | 3 |                            |     |
| Hardware .....                          | 3 |                            |     |

## FEATURES

- Durable steel frame for a long life.
- Easily assembled with the included instructions

## SAFETY PRECAUTIONS

### **ATTENTION**

#### **Use the correct bolts**

- Use the correct bolts as indicated. Do not tighten any of the bolts until the product is completely assembled.

#### **Do not discard packaging**

- Do not discard any of the packaging until you have checked that you have all of the required parts.



#### **Keep children away during assembly**

- This item contains small parts that can be swallowed by children. Children should always be under direct adult supervision while using this product.
- Retain assembly instructions for future reference.

## PRE-ASSEMBLY

- Carefully remove all pieces from the carton and make sure that you have all parts (refer to the hardware and parts content list).  
If you are missing parts, Email: [support@aeoutdoor.com](mailto:support@aeoutdoor.com) for further assistance.
- To avoid scratching your set, please assemble on top of the packaging cardboard or on top of a rug.

# MODEL DESCRIPTION

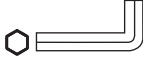

| SETUP   |   | TOOLS NEEDED  |
|---|---|---|
|  |  | <br>Allen key |

# FINISHED ASSEMBLED PRODUCT

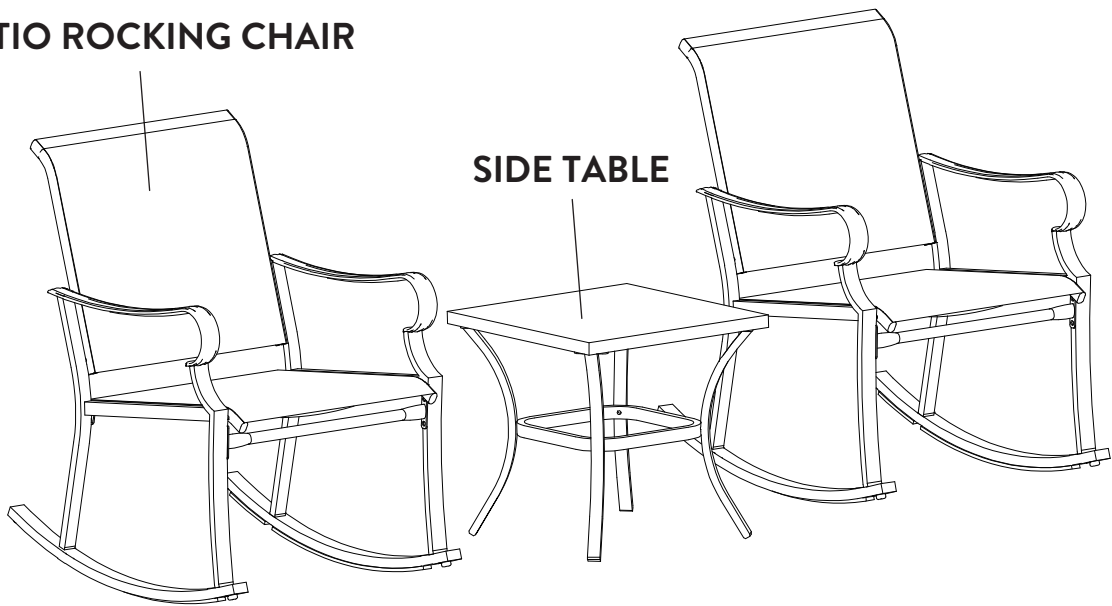



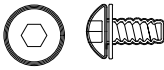
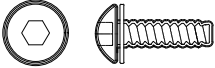

PATIO ROCKING CHAIR

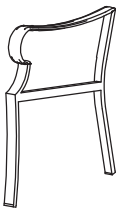
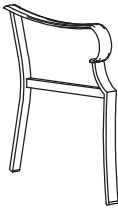

# HARDWARE

| PART | DESCRIPTION | PICTURE  | QTY |
|------|-------------|--|-----|
| AA   | BOLT(M6X15) |  | 20  |
| BB   | BOLT(M6X30) |  | 24  |
| CC   | ALLEN KEY   |  | 1   |

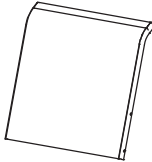
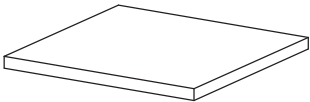
# PARTS DIAGRAM

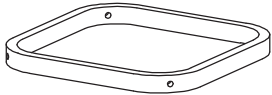
|   |   |   |
|---|---|---|
|    |    |    |
| <b>A X2</b><br>Right armrest  | <b>B X2</b><br>Left armrest   | <b>C X4</b><br>Rocking rail   |
|    |    |    |
| <b>D X2</b><br>Front cross tube   | <b>E X2</b><br>Seat panel   | <b>F X2</b><br>Back panel   |
|  |  |  |
| <b>G X1</b><br>Table top  | <b>H X4</b><br>Table leg  | <b>I X1</b><br>Mounting bracket   |

# ASSEMBLY

## 1. PATIO ROCKING CHAIR

### STEP 1

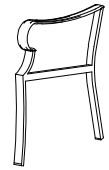
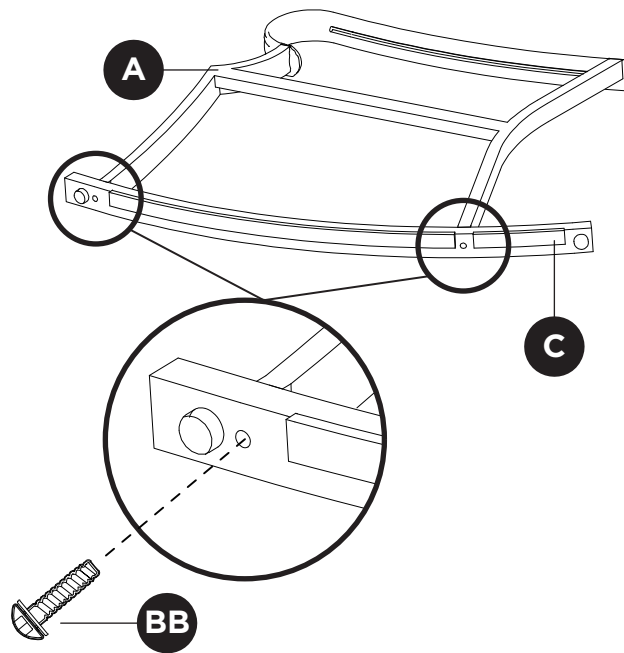

**A** x1

Right armrest



**C** x1

Rocking rail

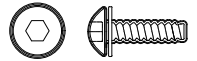

**BB** x2

BOLT(M6X30)

### STEP 2

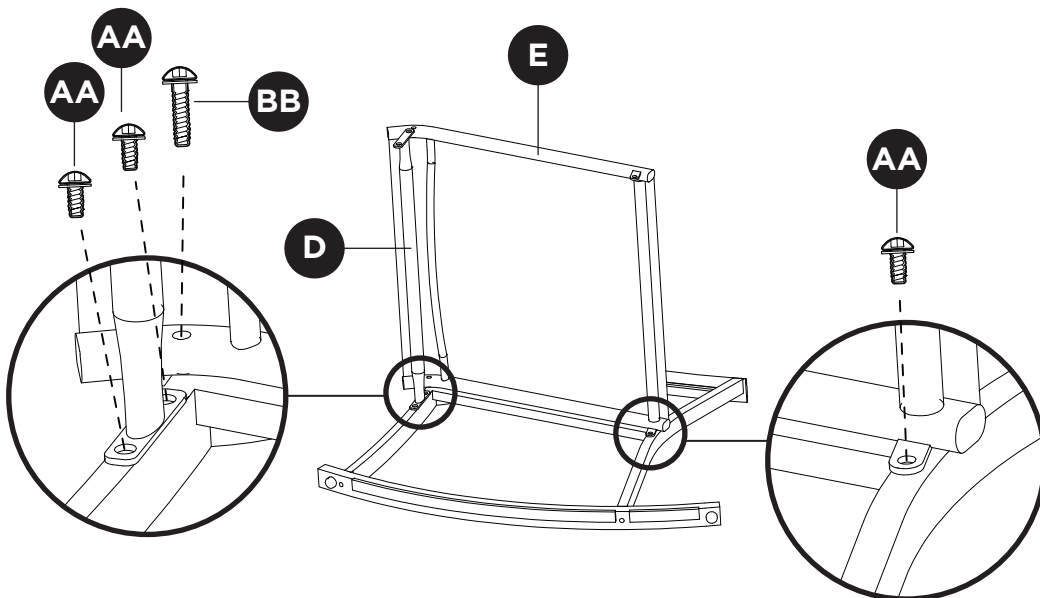

**D** x1

Front cross tube



**E** x1

Seat panel



**AA** x3

BOLT(M6X15)



**BB** x1

BOLT(M6X30)

# ASSEMBLY

## PATIO ROCKING CHAIR

STEP 3

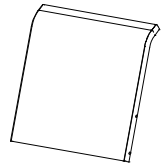
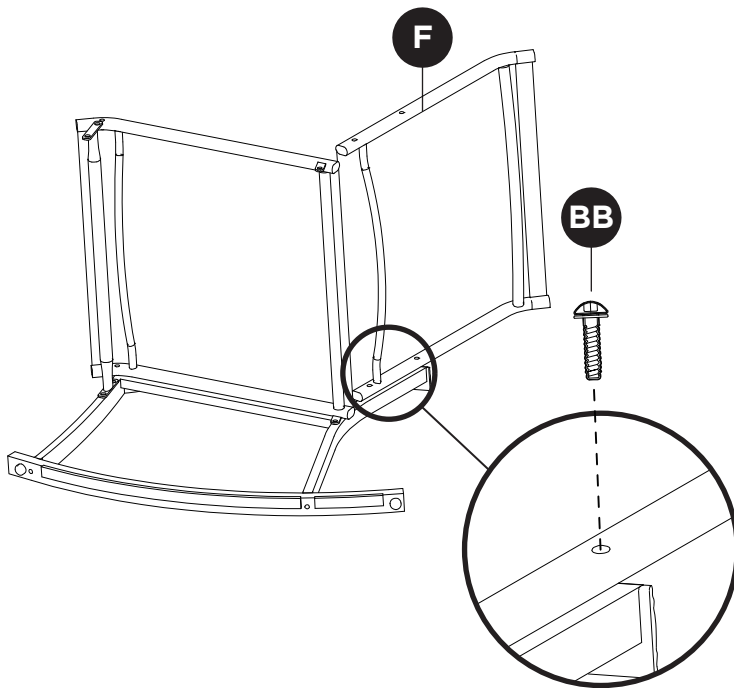

**F** x1  
Back panel

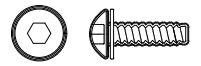

**BB** x2  
BOLT(M6X30)

STEP 4

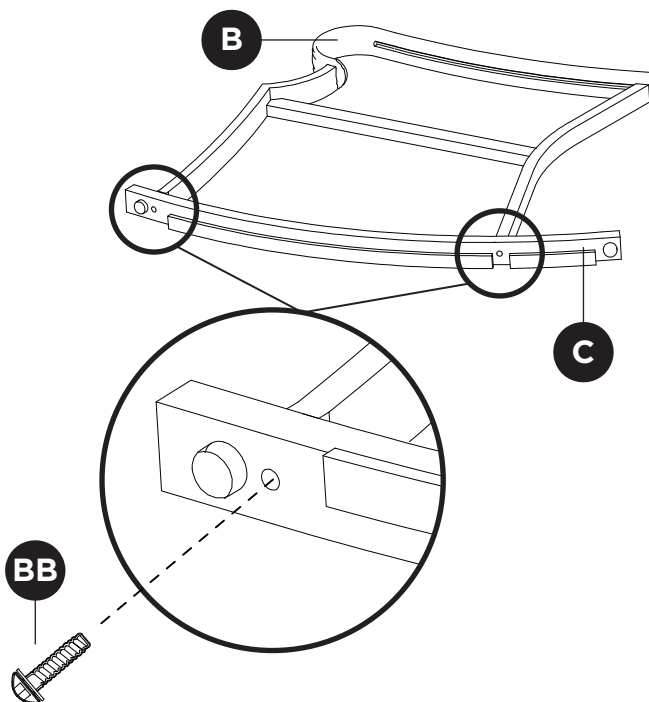

**B** x1  
Left armrest



**C** x1  
Rocking rail



**BB** x2  
BOLT(M6X30)

# ASSEMBLY

## PATIO ROCKING CHAIR

STEP 5

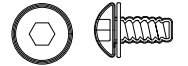
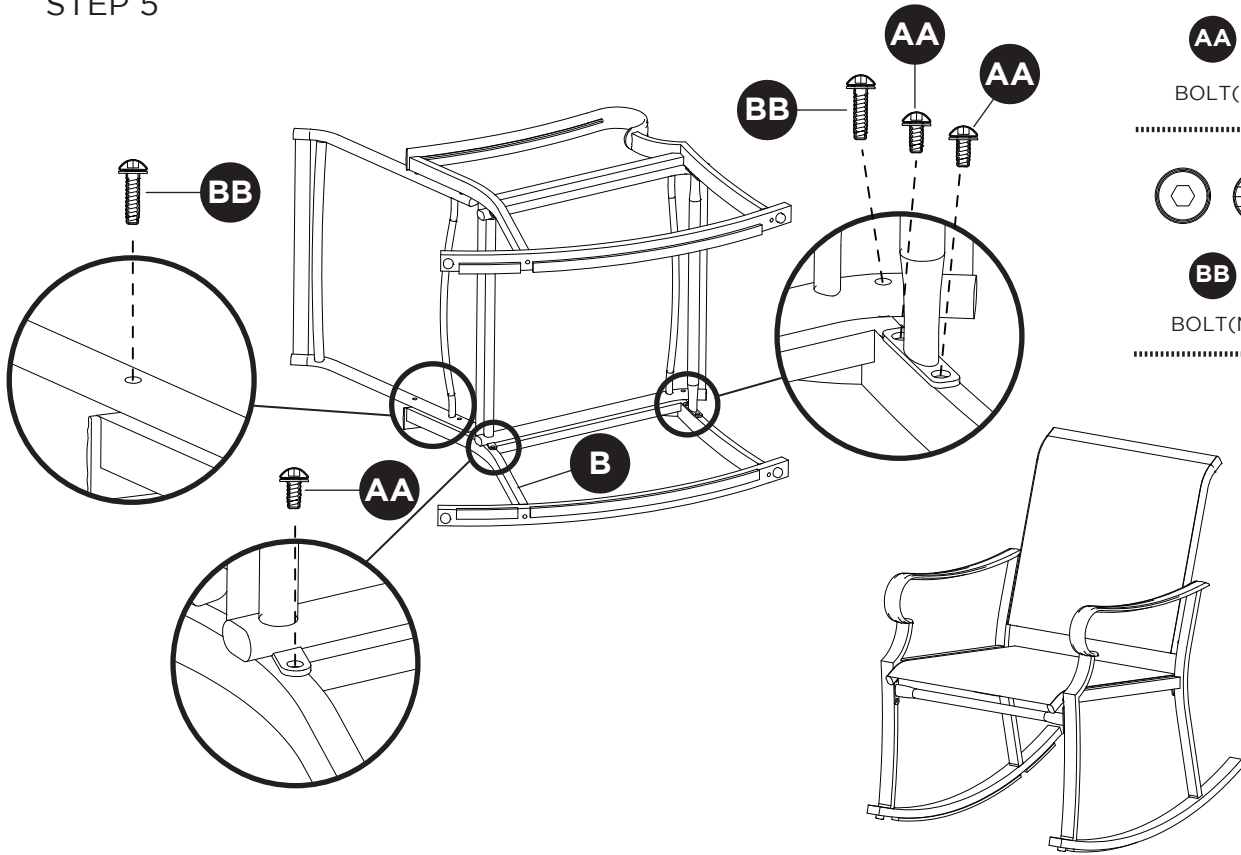

**AA x3**

BOLT(M6X15)

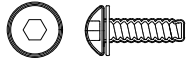

**BB x3**

BOLT(M6X30)

## SIDE TABLE

STEP 1

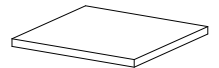
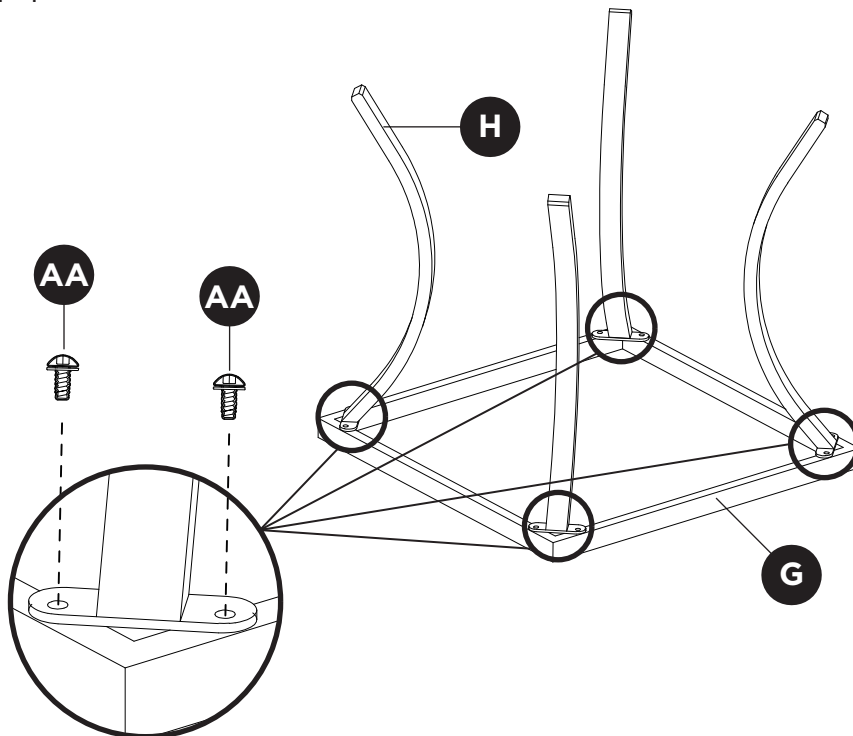

**G x1**

Table top



**H x4**

Table leg

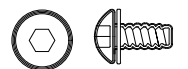

**AA x8**

Bolt(M6X15)

# ASSEMBLY

## SIDE TABLE

STEP 2

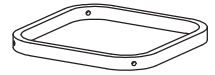
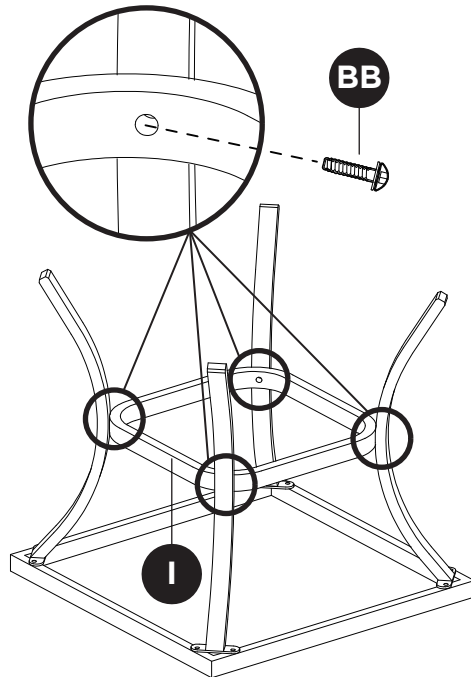

**I** x1

Mounting bracket

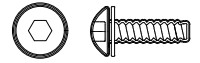

**BB** x4

BOLT(M6X30)

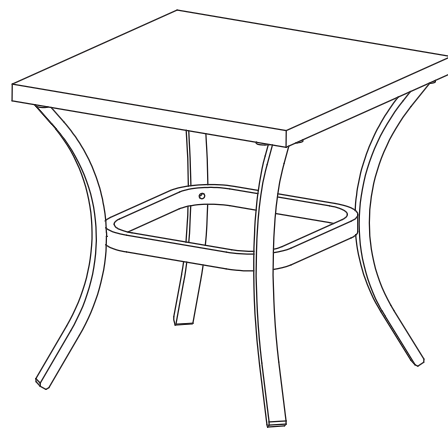

## CARE AND MAINTENANCE

- Use a furniture cover when not in use.
- Inspect and tighten all bolts and fasteners on a regular basis to ensure the proper performance and safety of your product.
- In order to prolong the life and beauty of your furniture, we recommend that it be stored in a dry and protected area during off season periods.
- Be careful to never allow water to build up in the frames as this will cause corrosion and freeze damage in cold climates.
- Wash all frames with a solution of mild soap and water. Rinse with clean water and dry with a soft absorbent cloth towel.
- Frames can be treated with a liquid wax for maximum protection against UV rays and/or salty, damp air.
- Do not use bleach or solvents to clean any product!

Should you have any issues, please don't hesitate to contact us.

**Email: [Support@aeoutdoor.com](mailto:Support@aeoutdoor.com)**



AE OUTDOOR.  
[www.aeoutdoor.com](http://www.aeoutdoor.com)