

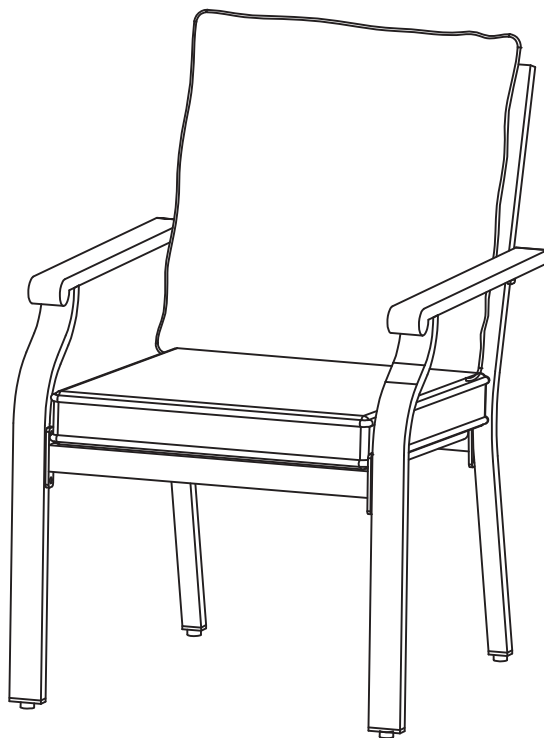

Instruction Manual

AE OUTDOOR 2PC DINING CHAIR

Item No. DQ10990



For product assistance &
missing or replacement parts:
WE CAN HELP

 Support@aeoutdoor.com

www.aeoutdoor.com

CONTENTS & INFORMATION

| | | | |
|---|---|-----------------------------------|-----|
| Contents & Information | 2 | Parts Diagram | 4 |
| Safety Precautions | 2 | Assembly | 4-6 |
| Pre-as Sembly | 2 | Care And Maintenance | 7 |
| Model Description | 3 | Unpacking Instructions ... | 7 |
| Finished Assembled Product | | | |
| | 3 | | |
| Hardware | 3 | | |

FEATURES

- Soft polyester covered cushions with a weather resistant coating.
- Durable steel frame for a long life.
- Easily assembled with the included instructions

SAFETY PRECAUTIONS

ATTENTION

Use the correct bolts

- Use the correct bolts as indicated. Do not tighten any of the bolts until the product is completely assembled.

Do not discard packaging

- Do not discard any of the packaging until you have checked that you have all of the required parts.



Keep children away during assembly

- This item contains small parts that can be swallowed by children. Children should always be under direct adult supervision while using this product.
- Retain assembly instructions for future reference.

PRE-ASSEMBLY

- Carefully remove all pieces from the carton and make sure that you have all parts (refer to the hardware and parts content list).
If you are missing parts, Email: support@aeoutdoor.com for further assistance.
- To avoid scratching your set, please assemble on top of the packaging cardboard or on top of a rug.

MODEL DESCRIPTION

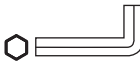
| SETUP | | TOOLS NEEDED |
|---|---|---|
|  |  |  Allen key |

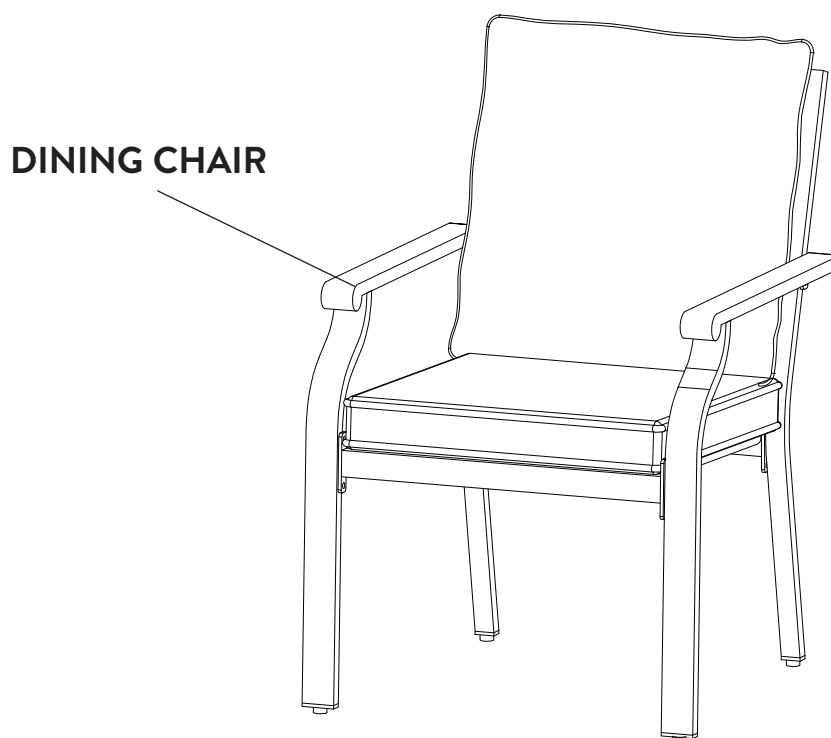

FINISHED ASSEMBLED PRODUCT

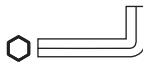

HARDWARE

| PART | DESCRIPTION | PICTURE | QTY |
|------|-------------|--|-----|
| AA | BOLT(M6X15) |  | 20 |
| BB | ALLEN KEY |  | 1 |

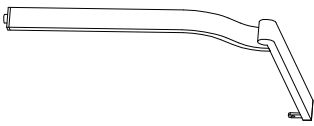
PARTS DIAGRAM

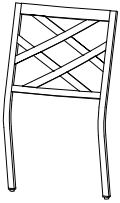
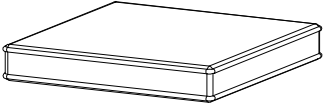
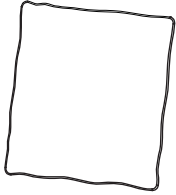
| | | |
|---|---|---|
|  |  |  |
| A X2 Left armrest | B X2 Right armrest | C X2 Seat frame |
|  |  |  |
| D X2 Back frame | E X2 Seat cushion | F X2 Back cushion |

ASSEMBLY

1. DINING CHAIR

STEP 1

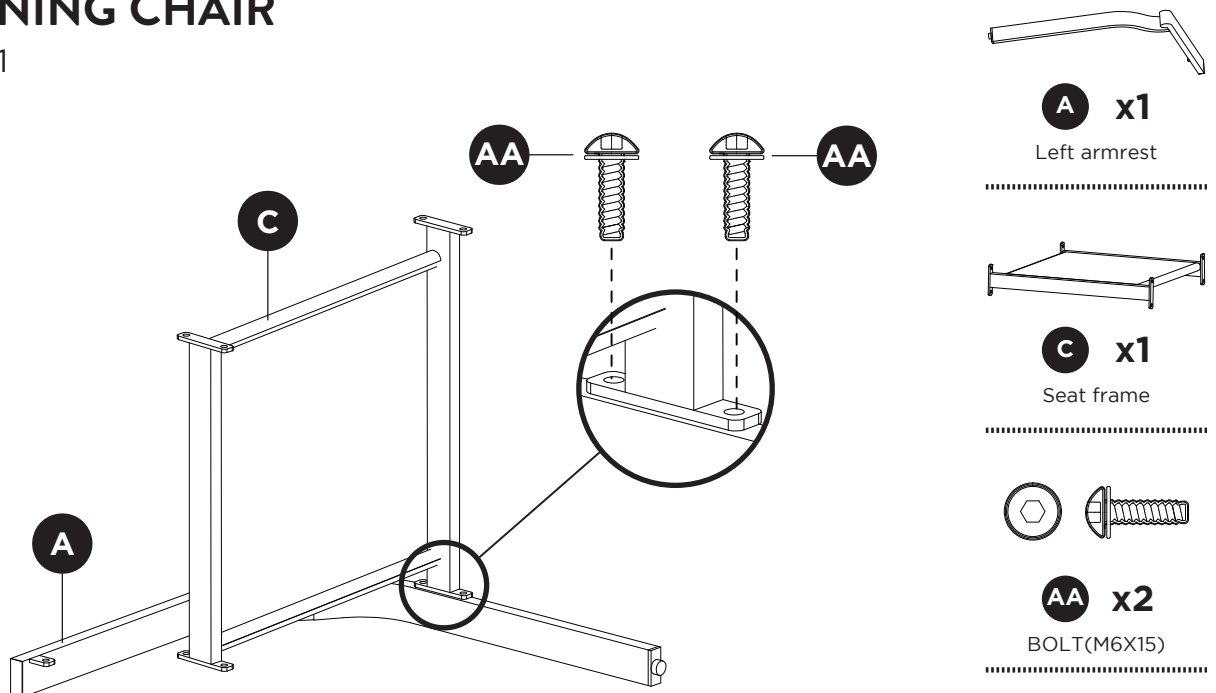

ASSEMBLY

DINING CHAIR

STEP 2

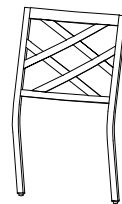
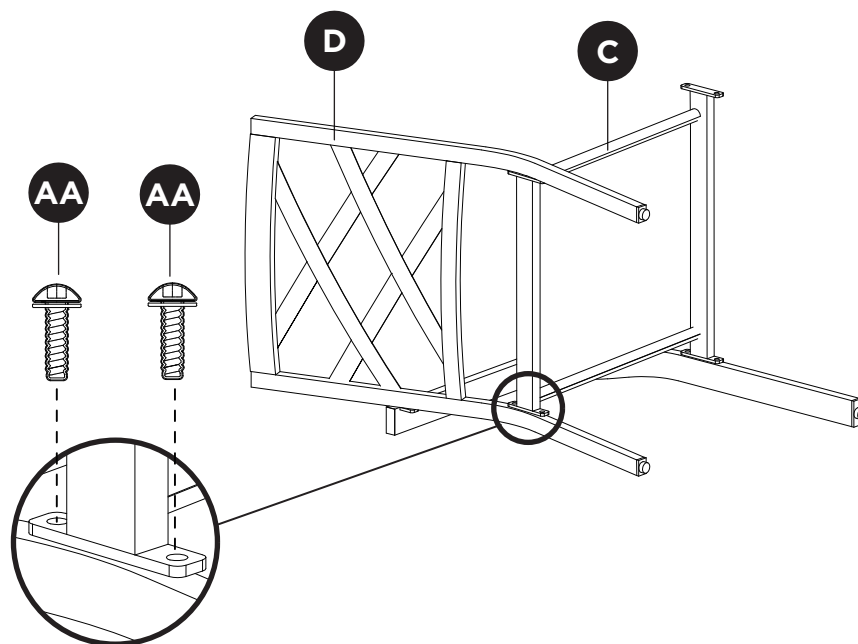

D x1
Back frame



AA x2
Bolt(M6X15)

STEP 3

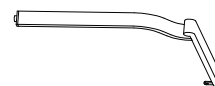
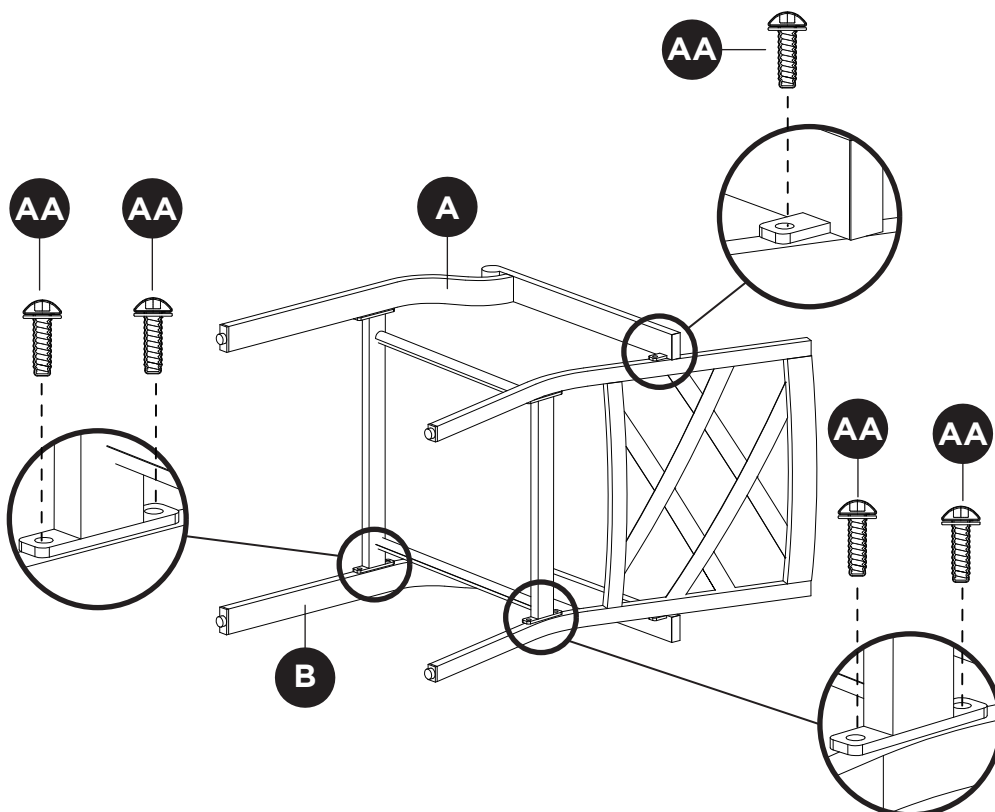

B x1
Right armrest



AA x5
BOLT(M6X15)

ASSEMBLY

DINING CHAIR

STEP 4

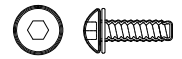

AA x1

Bolt(M6X15)

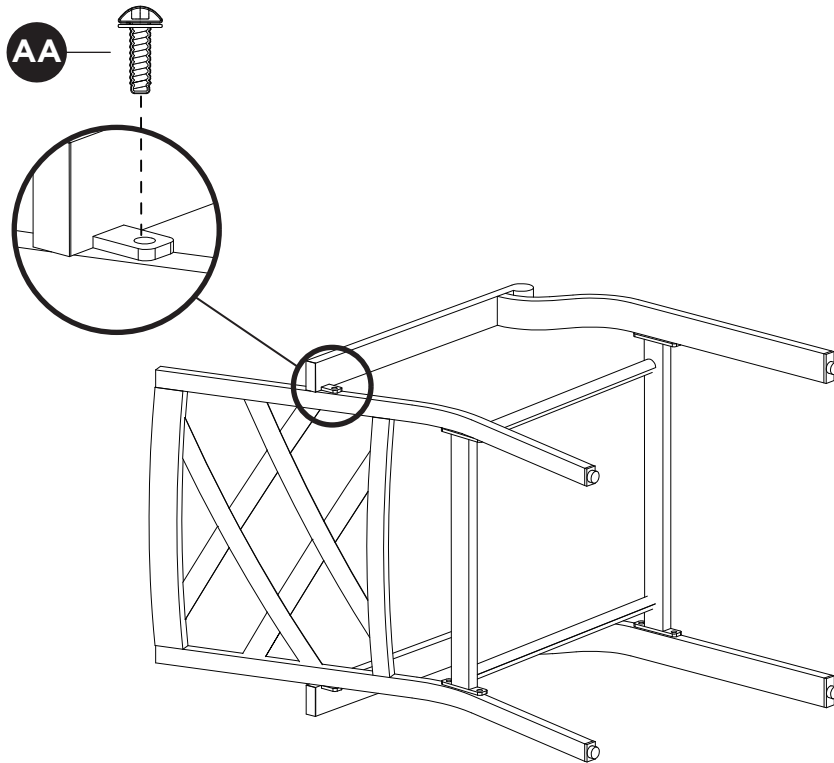

STEP 5

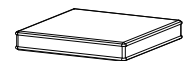

E x1

Seat cushion

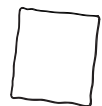
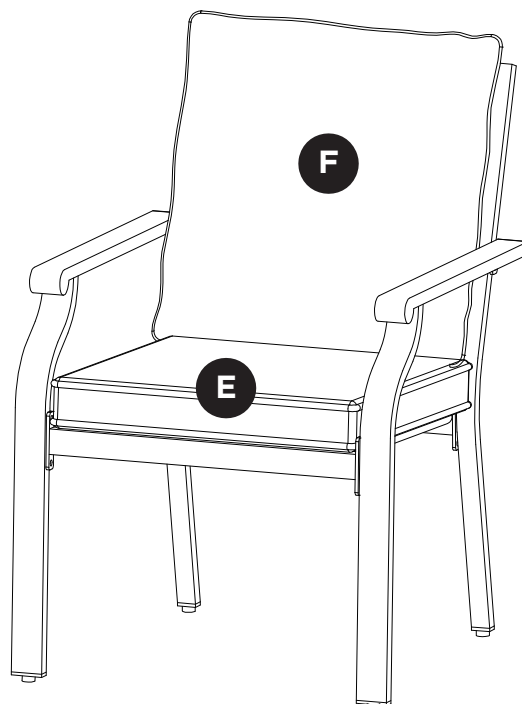

F x1

Back cushion

CARE AND MAINTENANCE

- Use a furniture cover when not in use.
- Inspect and tighten all bolts and fasteners on a regular basis to ensure the proper performance and safety of your product.
- In order to prolong the life and beauty of your furniture, we recommend that it be stored in a dry and protected area during off season periods.
- Be careful to never allow water to build up in the frames as this will cause corrosion and freeze damage in cold climates.
- Wash all frames with a solution of mild soap and water. Rinse with clean water and dry with a soft absorbent cloth towel.
- Frames can be treated with a liquid wax for maximum protection against UV rays and/or salty, damp air.
- Never machine wash cushions, as this will result in shrinkage or damage.
- If your set includes cushions, they may be cleaned by hand with mild soap and water, and rinsed off with clean water.
- After cleaning, leave the cushions upright to allow water to drip and dry. (Never use a commercial or home dryer to dry fabric).
- Do not use bleach or solvents to clean any product!
- Back cushion maintenance: Fluff in cool air dryer (20 min max). Applies exclusively to back cushions.

UNPACKING INSTRUCTIONS

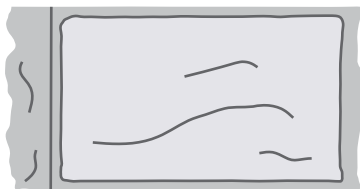

- 1.** Cushion is vacuum packed / flat and compressed.

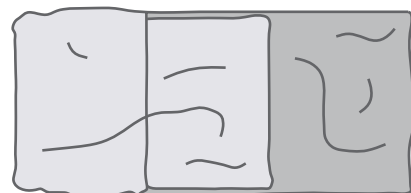

- 3.** Remove the cushion from the bag.

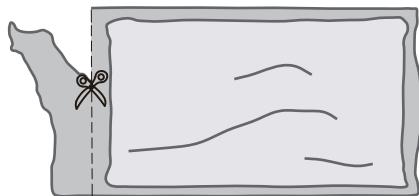

- 2.** Carefully cut the plastic cover along the edge to remove the cushion. Make sure you do not cut the cushion.

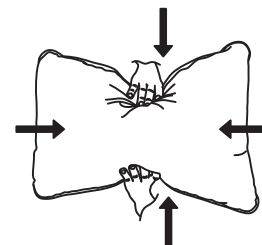

- 4.** Re-fluff lightly with hands. The cushion will return to its full size in a few hours.

Should you have any issues, please don't hesitate to contact us.

Email: Support@aeoutdoor.com



AE OUTDOOR.
www.aeoutdoor.com